



INVOLAR

Micro-Inverters

eGate

INVOLAR Grid-Connected Photovoltaic
Power Interface

Model Number PIU4KA-230-UK

User Operating Manual

(Version_eGate(UK)G83_PIU4KA_1.5)



This manual is an integral part of the unit. Please read the instruction manual carefully before installation, operation or maintenance. Keep this instruction manual for future reference.

Contact Information

Involar Corporation Ltd
887 Zuchongzhi Road, #84-407, Shanghai, 201203, China

Tel: 86-21-50272208

Fax: 86-21-50277705

Web: www.involar.com

E-mail: info@involar.com

TABLE OF CONTENTS

1	READ THIS FIRST	4
2	SAFETY SYMBOLS	5
2.1	SYMBOLS REPLACE WORDS ON THE EQUIPMENT, ON A DISPLAY OR IN MANUALS	6
2.2	TECHNICAL COMPETENCE	8
2.3	SAFETY INSTRUCTIONS AND EC DIRECTIVES	8
3	FEATURES	10
3.1	STRUCTURE OF EGATE	10
3.2	SAFETY POWER LIMITING FOLD-BACK TECHNOLOGY	11
3.3	TECHNICAL PARAMETERS	12
4	INSTALLATION	13
4.1	OPERATING CONDITION	13
4.2	SYSTEM DIAGRAM	14
4.3	CIRCUIT DIAGRAM	15
4.4	INSTALLATION PROCEDURE	16
5	OPERATING STATUS	19
5.1	WORKING MODE	19
5.2	GRID-CONNECTION	20
5.3	GRID DISCONNECT	20
5.4	INSTALLATION CHECKLIST	20
5.5	START-UP- CHECKS	21
5.6	DISCONNECTING THE EGATE FROM THE SYSTEM	21
6	MONITORING AND TROUBLESHOOTING AND MAINTENANCE	22
6.1	SAFETY CHECKS	22
6.2	MAINTAIN PERIODICALLY	22
6.3	EGATE STATUS LED INDICATIONS AND ERROR REPORTING	22
6.4	INTERNET WEB	23
	APPENDIX	24
6.5	LIMITED WARRANTY	24
6.6	EC DECLARATION OF CONFORMITY	25

1 Read This First





Involar's new product "eGate" acts as the power interface (PI) to the utility grid. It is a separate device installed at the coupling point to the utility grid to provide the safety functions such as over/under voltage, over/under frequency, active anti-islanding as well as lightning protection. It uses line impedance stabilizing network (LISN) and modular design capability. The data of real-time performance information of energy harvest for all Involar micro-inverters is collected by the eGates built in Energy Terminal Unit (ETU) and is transmitted to Involar Solar Energy Data Acquisition System (SEDAS) via the internet for monitoring.

This user manual includes eGate overview, installation, operation instruction and technical parameters. To assure safe correct installation and operation, please carefully read this user manual before installation and pay attention to the safety symbols affixed on the product label.











2 Safety Symbols

Warnings and cautions indicate possible dangerous conditions that can occur if instructions are not carefully read and followed.

Please read the following safety symbols and important safety instructions.

	<p>DANGER</p> <p>The DANGER symbols in this manual and on the eGate indicates a hazard with a high level of risk which if not avoided, will result in death or serious injury.</p>
	<p>WARNING</p> <p>The WARNING symbols in this manual and on the eGate indicates a hazard with a medium level of risk which if not avoided, could result in death or serious injury.</p>
	<p>CAUTION</p> <p>The CAUTION symbols in this manual and on eGate indicates a hazard with a low level of risk which if not avoided, could result in minor or moderate injury.</p>
	<p>NOTE</p> <p>The NOTE symbols in this manual indicate the important product information.</p>

2.1 Symbols replace words on the equipment, on a display or in manuals.

	Trademark
	No access for unauthorized personnel
	Caution- risk of danger
	Symbol for the marking of electrical and electronics devices according to Directive 2002/96/EC. Indicates that the device, accessories and the packaging must not be disposed as unsorted municipal waste and must be collected separately at the end of the usage Please follow Local Ordinances or Regulations for disposal or contact an authorized representative of the manufacturer for information concerning the decommissioning of equipment.
	Direct current
	Alternating current
PE	Protective conductor
	Earth (ground) TERMINAL
	Protective Conductor Terminal
	Fuse
	Refer to the operating instructions
	Caution- risk of electric shock
CE	CE mark is attached to the solar eGate to verify that the unit follows the provisions of the European Low Voltage and EMC Directives
PV	Photovoltaic
+	DC terminal, indicating the polarity of the connections, positive, all positive connections shall be made with Red insulated wires

-	DC terminal, indicating the polarity of the connections, negative, all negative connections with black insulated wires
PCS	Power conversion equipment, refers to our DC/AC inverter
Service Personnel	A person having appropriate technical training and experience necessary to be aware of hazards to which that person may be exposed in performing a task and of measures to minimize the risks to that person or other persons
Qualified personnel/ Competent person	Persons adequately advised or supervised by an electrically skilled person to enable him or her to perceive risks and to avoid hazards which electricity can create. For the purpose of the safety information of this manual, a "qualified person" is someone who is familiar with requirements for safety, refrigeration system and EMC and is authorized to energize, ground, and tag equipment, systems, and circuits in accordance with established safety procedures. The eGate and endues system may only be commissioned and operated by qualified personnel.
DVC	Decisive voltage class
Closed Electrical Operating Area	Room or location for electrical equipment to which access is restricted to skilled or instructed persons by the opening of a door or the removal of a barrier by the use of a key or tool and which is clearly marked by appropriate warning signs.

2.2 Technical Competence

The procedures described in this manual should be performed by a competent persons only. Maintenance should only be undertaken by competent individuals who have a general knowledge of and experience with devices of this nature. No repairs should ever be undertaken or attempted by anyone not having such qualifications.

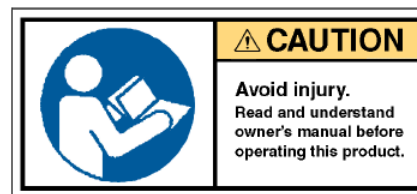

Compliance with safety regulations is imperative for installing and configuring the system safely and correctly, including using the specified cables. Only competent assemblers who are familiar with requirements for safety, Photovoltaic systems and EMC must install the system. The assembler is responsible for ensuring that the end system complies with all the relevant regulations in the country where it is to be used.

Involar require using only genuine replacement parts, manufactured or sold by Involar for all repairs or replacements.

Read carefully through each step in every procedure before commencing installation; any exceptions may result in a failure to properly and safely complete the installation.

Servicing of this product in accordance with this manual should never be undertaken in the absence of proper tools, test equipment and the most recent revision to this manual, which is clearly and thoroughly understood.

2.3 Safety Instructions and EC Directives

This chapter contains the safety instructions that you must follow when installing, operating and servicing the unit. If ignored, physical injury or death may follow, or damage may occur to the unit. Read the safety instructions before you commence work on the unit. If you are unable to understand the Dangers, Warnings, Cautions or Instructions, contact the manufacturer or an authorized service dealer before installing, operating and servicing the unit.

To ensure your personal safety and the proper use of eGate, please carefully read this manual before commencing installation. If the product is damaged when installation has not been carried out in compliance with this manual, Involar do not accept any responsibility for any quality assurances and or other risks which may occur.

For INVOLAR eGate Warranty Terms and Conditions, see the appendix of this manual.

- **CAUTION** Be aware that only competent qualified personnel should install, maintain and/or replace INVOLAR eGate.
- **WARNING** The installation that connects the equipment to the Supply terminals shall comply with the requirements of BS 7671.
- **WARNING** Electrical installation of PV system shall comply with the requirements of BS 7671 and IEC 60364-7-712.
- **WARNING** No protection settings can be altered.
- **WARNING** User shall ensure that the equipment is so installed, designed and operated to maintain at all times, compliance with the requirements of ESQCR 22(1)(a).

- **CAUTION** Compliance with the rules of correct use of tools and personal protective equipment (PPE) for ensuring the eGate safe installation.
- **WARNING** Connection of any photovoltaic system to the electrical utility grid should only commence after receiving prior approval from the utility company.
- **CAUTION** The eGate must be installed in an environment suitable for its IP rating.
- **WARNING** This unit is provided with fixed trip limits and shall not be aggregated above 3.68kW on a single point of common connection.
- **CAUTION** The device is intended for fixed installation. Located on a part that is not removable without shutdown to the operation of the unit.
- **WARNING** - Risk of electric shock- Do not open cover. No user serviceable parts inside. Servicing limited to qualified service personnel.
- **WARNING** - The output connection with AC grid shall be protected by a max. 16A circuit breaker.
- **WARNING** – This device is not provided with a GFDI device. This interface unit must be used with an external GFDI device as required by article 690 of the National Electrical Code for the Installation location.
- **WARNING** - The printed circuit boards contain components sensitive to electrostatic discharge. Wear a grounding wrist band when handling the boards. Do not touch the boards unnecessarily.
- **WARNING** - Do not operate any device which is damaged, lacking parts or dented. Failure to observe this warning may result in an electric shock, injury, fire or accident.
- **WARNING** - Before installing the unit make sure the local Distribution Network Operator is completely informed about all the components, and system specification of the full system being installed. The installation should only commence if there is a written permission to install the designated components.



WARNING:

IMPORTANT: the input AC voltage of the INVOLAR eGate shall not exceed the rated voltage; higher voltage may cause permanent damage to the device. It contains no user serviceable and INVOLAR-eGate Warranty parts.



CAUTION:

SAVE THESE INSTRUCTIONS– This manual contains important instructions for eGate that shall be followed during installation and maintenance.

3 Features

3.1 Structure of eGate

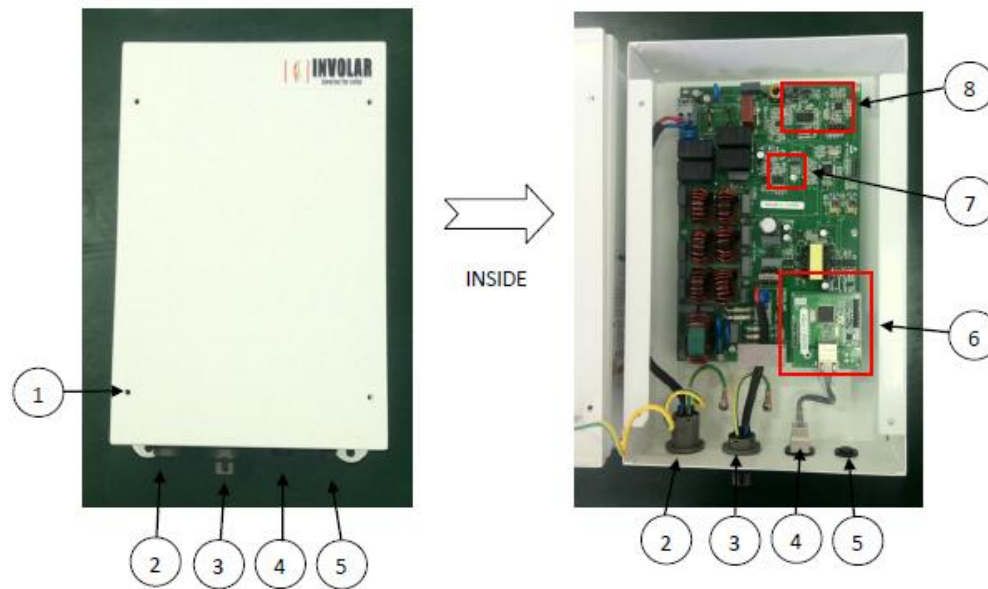

Figure 3.1.1 Structure of eGate

- ① Cover Fixing Screws
- ② PV Power Plant Input Cable
- ③ Grid Output Cable
- ④ Ethernet Cable (Optional)
- ⑤ Can bus Cable (Optional)
- ⑥ Communication module (Optional)
- ⑦ LED
- ⑧ ETU module

3.2 Safety Power Limiting Fold-back Technology

To provide a safe and flexible system design the eGate has an Intelligent 'Fold-Back' Technology, which when required will communicate with one or more of the inverters within a branch circuit to reduce its power output. There are two areas where the technology is applied;

1. Fold-back at eGate level: the current shall NOT exceed 16A under whatever circumstances;
2. Fold-back at MG level: the MG's casing shall NOT exceed the maximum temperature it is allowed;

Therefore, for eGate "the eGate shall regulate the total current flowing through it through PLC to the micro inverters, so to limit that current to 16A"

For MG "the micro inverter shall lower its output power should the casing temperature exceed the maximum allowed limit".

3.3 Technical Parameters

Model	PIU4KA-230-UK
Input Data (AC)	
Rated input power	3.68KW
Rated input voltage	230V
Rated input current	16A
Rated input frequency	50Hz
Output Data (AC)	
Rated output power	3.68KW
Rated output voltage	230V
Rated output current	16A
Output voltage range	207V~264V
Output frequency range	47Hz~50.5Hz
Total current harmonic distortion	<2%
Efficiency	99.6%
Electrical Portal	
Grid and Array	Double Relay
Grid	Connect to Grid
Array	Connect to Array
Mechanical Data	
Enclosure environmental rating	IP40
Operating temperature range	-20°C~+45°C
Dimensions (WxHxD) in mm	225.4x342.4x80mm
Weight	3.43kg
Features	
Compliance	G83
Warranty	25 Years (UK ONLY)
Response time for active anti-islanding	2s
Night time Power consumption	3W
Over/ Under voltage protection	Yes
Over/ Under Frequency protection	Yes
Over current protection	Yes
Short circuit protection	Yes
Loss of mains protection	Yes
Lightning surge protection	Yes
DC Injection control	Yes
Leakage current control	Yes
Current Fold-Back Technology	Yes
High frequency line impedance stabilization Network (LISN)	Yes

4 Installation

4.1 Operating Condition

Operating Temperature

Ambient temperature: $-20^{\circ}\text{C} \sim +45^{\circ}\text{C}$ 。

Operating Humidity

Air Relative Humidity $\leq 90\%$

Rated Input

AC230V/50Hz

4.2 System diagram

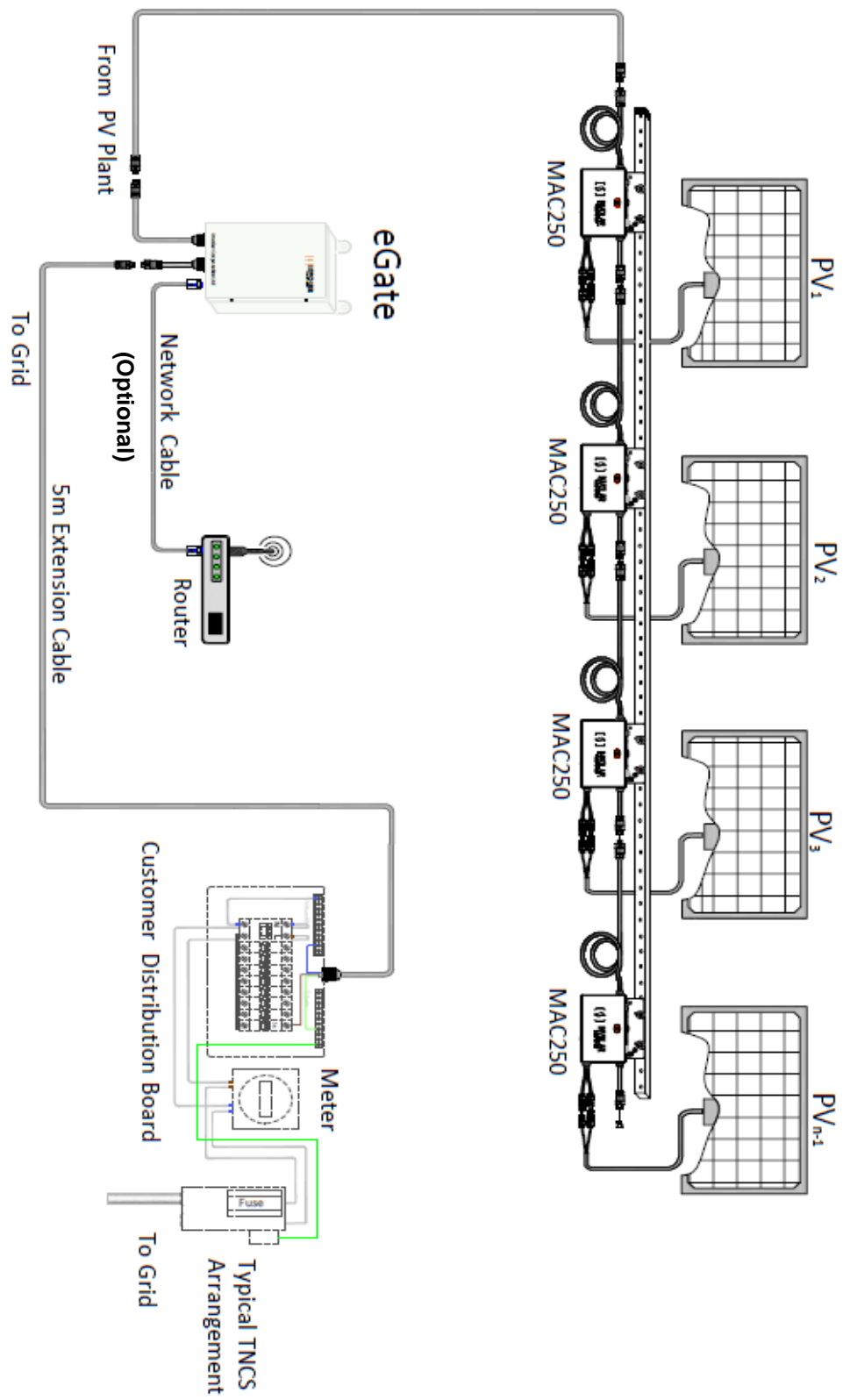

Figure 4.2.1 System diagram

4.3 Circuit Diagram

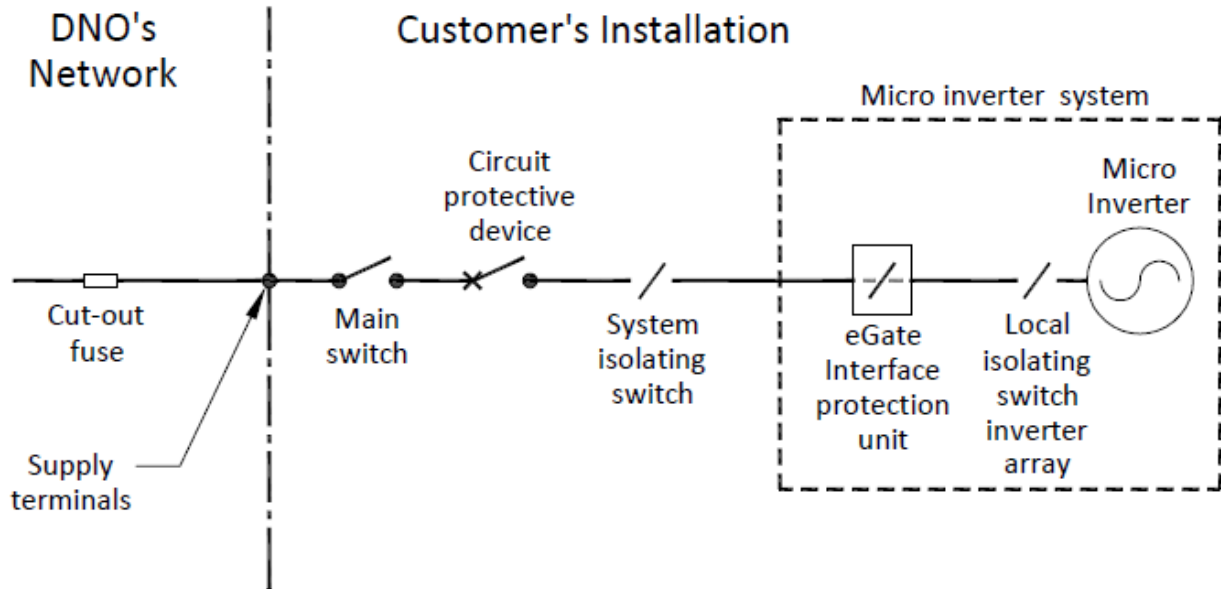

Figure 4.3.1 Circuit diagram of micro inverter installation.

4.4 Installation Procedure

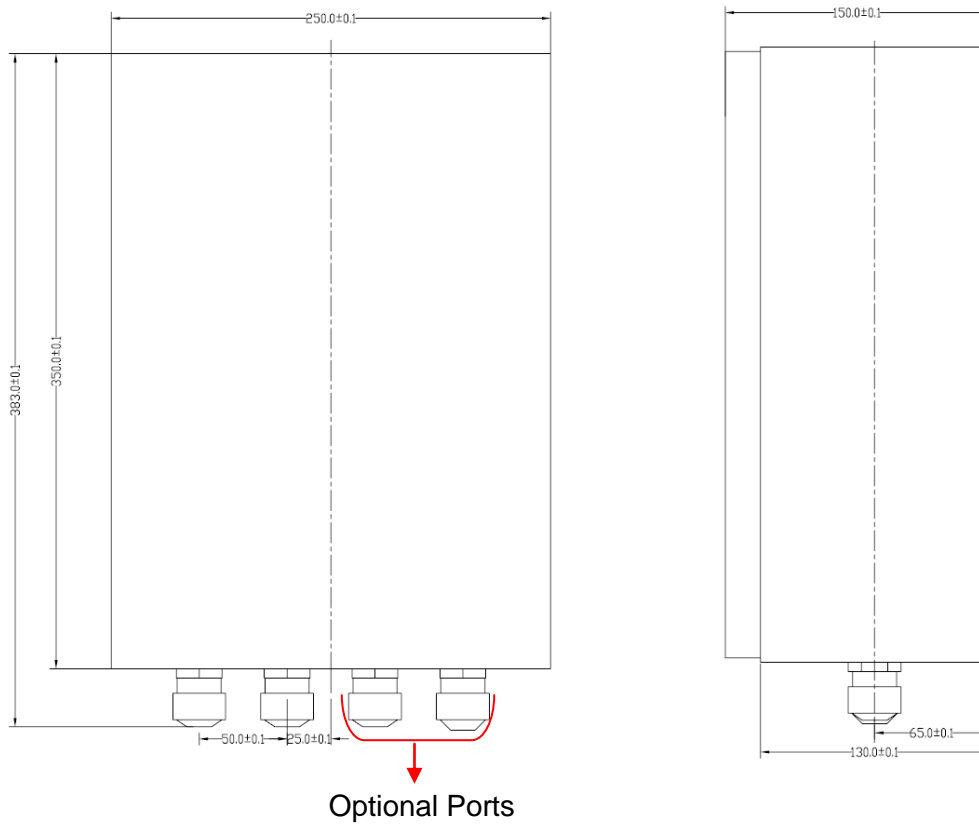



Figure 4.4.1 Dimension of eGate

	<p>Warning</p> <ul style="list-style-type: none">• eGate MUST connect to earth effectively.• Please ensure proper use of tools and correct personal protective equipment (PPE) are worn when carrying out installation.
	<p>Caution</p> <p>Installation of power supply cable and CAN Bus/ Ethernet cables must be separate from each other. Do not place these cables on the same containment.</p>

Installation Diagram

See below Figure 4.4.2.

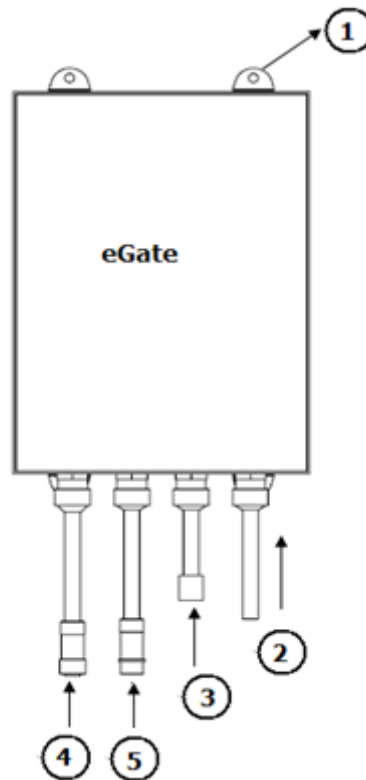

Figure 4.4.2 Installation Diagram

- ① Mounting brackets. (2 top & 2 bottom)
- ② CAN Bus cable entry. (Optional)
- ③ Ethernet cable entry. (Optional)
- ④ AC cable to PV array.
- ⑤ AC cable to grid.

Table 4.4.3 AC Input Terminal



Green/Yellow - PE Blue - N Brown - L			Pin1-Green/Yellow Pin2-Blue Pin3-Brown
--	---	--	--

Diagram 4.4.4 AC Connections

Step1: Mount eGate cabinet to the wall or a fixed structure.

Step 2: Connect the extension cable from the micro inverters to the input socket of the eGate marked 'PV ARRAY'.

Step 3: Connect the extension cable with one bare end for grid point connection to the output socket marked 'GRID'.

Step 4: (Optional) Connect eGate to the router via Ethernet port using cable provided.

Step5: (Optional) Connect the CAN bus terminal of eGate to other eGate units for data transmission.



Line up the connectors correctly and push together.



To release use a terminal screwdriver to push and release clip then pull apart.

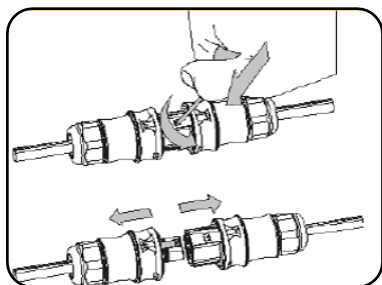

5 Operating Status

INVOLAR's new product "eGate" acts as the power interface (PI) to the utility grid. It is a separate device installed at the coupling point to the utility grid to provide the safety functions such as over/under voltage, over/under frequency, and especially active anti-islanding protection as well as lightning protection and line impedance stabilizing network (LISN), modular design. The data of real-time performance information of energy harvest for all INVOLAR micro-inverter systems can be collected by eGate, and be transmitted to INVOLAR Solar Energy Data Acquisition System to achieve a global data monitoring for PV power plant. It realizes the connection between solar power plant and internet. As an intelligent communication gateway, eGate uses INVOLAR's Power Line Communication (PLC) technology to continuously monitor the data of energy harvest of solar power plant such as power, voltage, current and frequency, it can also transmit the real-time data of energy harvest to INVOLAR's Solar Energy Data Acquisition System (SEDAS) to realize the monitoring around the world.

5.1 Working Mode

The working modes of an INVOLAR Micro-Inverter are:

- Start up
- Active
- Fault
- Standby

The detailed working mode descriptions are as below:

Start up

Start up mode is for a newly installed eGate. This start up mode is based on the correct AC connection, micro-inverter, Ethernet and or Can bus cables connecting.

Active

When the eGate is in normal operation process, this insures that the power available from micro-inverter array is exported to the utility grid. The LED inside of eGate will flash in green.

Fault

If the system does not operate correctly, INVOLAR eGate will stop automatically and enter into Disable mode. The INVOLAR eGate system keeps detecting the fault information, it shall remain in disable mode until the fault has cleared. Once the fault has been repaired the eGate shall start up and match to the electrical utility grid, the whole system would enter operation mode after 20 seconds to 5 minutes. Be aware that only qualified personnel should maintain the INVOLAR Micro-Inverter system. The LED will flash in yellow (communication fault) or red.

Standby

When the eGate is in operation process but keeps with low voltage and current in micro-inverter side for a certain time. The eGate manages transition from "Active" to "Standby". In "standby" mode, eGate keeps detecting the energy output of each micro-inverter. When the output energy reaches the power generation conditions, the inverter would enter into "Active" from the "Standby" state.



- The equipment maintenance must only be carried by competent persons. Maintenance personnel should be familiar with all the warnings in this manual and the proposed steps
- Must be sure to disconnect the input and output power before removal of equipment for maintenance.

5.2 Grid-Connection

The eGate system establishes grid characteristics automatically. It detects and monitors the performance of each PV module through each micro-inverter. When the output energy reaches the power generation conditions, the eGate system begin connect grid and generate electricity.



5.3 Grid Disconnect

If the state grid cannot match the following situations (table 5.1.1) the INVOLAR Micro-Inter will enter disabled mode.

Type	Rated	Variation Range
Voltage	230V	207V - 264V
Frequency	50Hz	47Hz – 50.5Hz

Table 5.1.1 Parameter of European state power grid

Follow the installation checklist before energizing the system:

	WARNING Connect the eGate to the electrical utility grid only after receiving prior approval from the utility company.
	WARNING Only competent qualified personnel to connect INVOLAR eGate to the electrical utility grid.

5.4 Installation checklist

To ensure the safe operation of the devices, installation and commissioning shall only be carried out by qualified personnel in full compliance with the warnings referred to in this manual.

Checklist

Check the mechanical and electrical installation of the unit before start up. Go through the checklist below together with another person. Read the Safety instructions and EC directives on the previous pages of this manual before you work on the unit.

Mechanical Installation

Check screw connections on the eGate for tightness.

The ambient operating conditions are allowed. (See Technical parameter);

The unit is fixed properly on a non-flammable wall. (See Mechanical installation.)

The cooling air will flow freely. The unit is fixed tightly and support is adequate. (See Mechanical installation.)

Electrical Installation

Check all screws of the connection terminals in the installation system before and after the inverter for tightness.

The AC output voltage matches the unit nominal voltage. Make sure that the total micro-inverter array current cannot exceed the permissible input current rating of the device.

The micro-inverter output cable and eGate input cable's connections and their tightening torques are OK.

There are no tools, foreign objects or dust from drilling inside the unit. Unit, connection box and other covers are in place.

The eGate output power cable and the main power connection is OK.

The Ethernet and Can bus (more than 2 eGate) connections are OK.

The external cords and cables are fixed tightly, and strain relief clamp is provided for external accessible cords and cables.

Cord and cable inlets are sealed completely after cord/cable installation.

5.5 Start-Up– Checks

The device has been checked at the factory and adjusted so that it can be commissioned immediately after being installed.

Following Section **Installation checklist**, for your personal safety and to avoid damage, the following safety checks should be performed before start by a qualified person who has adequate training, knowledge, and practical experience to perform these tests. The data should be recorded in an equipment log. If the device is not functioning properly or fails any of tests, the device has to be repaired.

1. Inspect the equipment and accessories for mechanical and functional damage.
2. Inspect the safety relevant labels for legibility.
3. Inspect the fuse to verify compliance with rated current and breaking characteristics.
4. Measurement of insulation resistance
5. Measurement of earth resistance
6. Mounting structures: Verify tightness and integrity of bolts and other fastening devices; Verify if there is any significant corrosion.

5.6 Disconnecting the eGate from the system

To ensure safe disconnection of the eGate from the solar power plant, it must **NOT** be carried out under load conditions. Ensure the following disconnection steps are carried out in the order shown:

1. Isolate the DC source with an opaque cover ensuring no power is being produced.
2. Disconnect the AC cable by isolating the branch via the circuit breaker at the distribution board.
3. Disconnect the AC cable from micro-inverter in the branch circuit.
4. Ensure the LED inside of eGate is off.
5. Disconnect the Ethernet and CAN bus cable if installed.
6. Remove the eGate from the system.

6 Monitoring and Troubleshooting and Maintenance



No user-serviceable parts inside, before servicing and in the event of internal malfunction the unit, send the eGate to authorized representative or manufacturer!
Never operate this product and change any part of eGate yourself.

Only competent personnel WHO ARE FAMILIAR WITH THE REQUIREMENTS OF SAFETY are allowed to perform servicing and maintenance work.

6.1 Safety checks

Safety checks should be performed at least every 12 months by a competent person who has adequate training, knowledge, and practical experience to perform these checks. The data should be recorded in an equipment log. If the device is not functioning properly or fails any of the tests, the device has to be repaired.

For safety check details, refer to this manual, section 3 Safety instruction and EC Directives.

6.2 Maintain periodically

Only competent qualified person to perform the following works.

During the lifetime of the eGate, the manage person shall examine and maintain the machine regularly. The operations are as follow.



1. Check the SEDAS (Solar Energy Data Acquisition System) website if the indicators the eGates are in normal state. This check should be performed at least every 6 months.
2. Check if the input and output wires are damaged or aged. This check should be performed at least every 6 months.
3. Check for dust or debris. If a build up of dust or debris occurs inside the eGate then lightly brush or vacuum the unit to remove dust particles which may cause the components to overheat.

6.3 eGate Status LED Indications and Error Reporting

eGate has an inside LED to indicate the status of the eGate. The following table 7.3.1 is the LED indications and error report.

LED Operation	Working Mode	Explain
2 short yellow blinks	Start up	
4 short yellow blinks	Producing power and not communicating with ETU	The power generation of micro-inverter is ok but the communication is no good
3 short yellow blinks	Standby	At night or no AC input power from micro-inverter
Flashing red continuously	Module Disable	MAC250 module disable in the PV system
2 short red blinks	Over current	PV module export over current
3 short red blinks	Voltage disable	Abnormal voltage in state grid
4 short red blinks	Frequency disable	Abnormal frequency in state grid
5 short red blinks	Island effect	Anti-island protection
Flashing green continuously	Normal mode	Power generation and communication is OK

Table 6.3.1 Status LED Indications and Error Reporting

	<p>WARNING</p> <ul style="list-style-type: none"> • Be aware that only qualified personnel should troubleshoot the INVOLAR Micro-Inverter or the eGate.
	<p>WARNING</p> <ul style="list-style-type: none"> • Never disconnect the DC wire connectors under load. Ensure that no current is flowing in the DC wires prior to disconnecting.

6.4 Internet WEB

Introduction

Use The SEDAS (Solar Energy Data Acquisition System) developed by Involar to real time track the statistics information of the energy harvest for all Involar Micro inverter system and monitor per-module's performance which is integrated into the Involar Micro inverter system.

User Registration

Registration Page: <http://test.involar.com:8000>

Select Language then click 'Register' and enter details.

Register with Involar provided License code, customer user name and password.

User Login

Login Page: <http://test.involar.com:8000>

Select the language of your preference.

Upon logging in, the following is shown

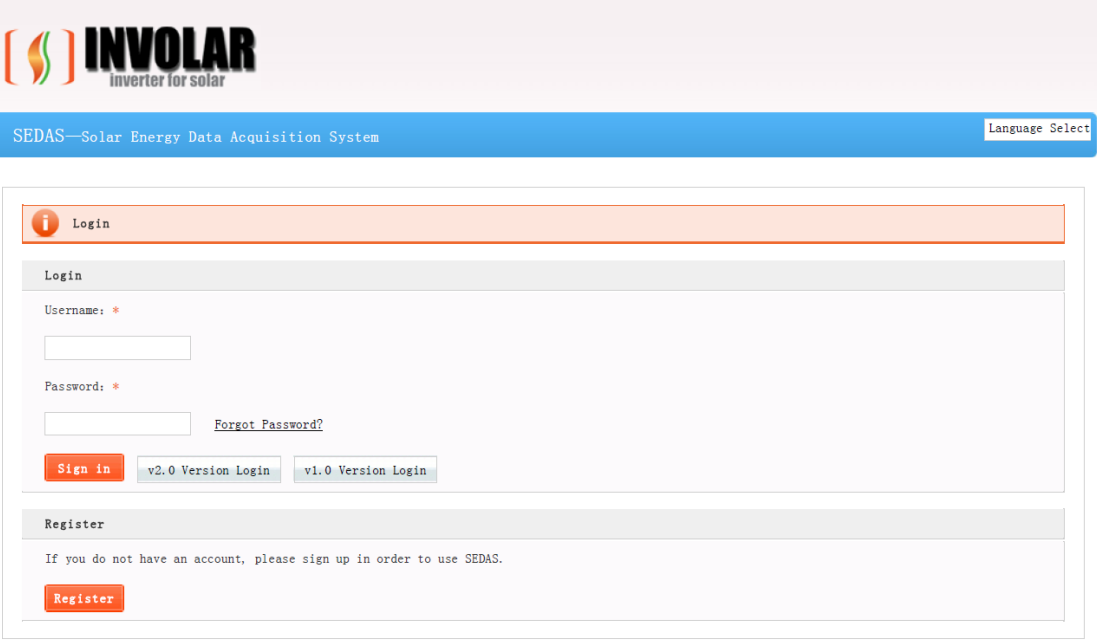

Please refer to the SEDAS User manual for the configuration process.

Appendix

6.5 Limited Warranty

INVOLAR provides the 25-year warranty (The exact time depends on the contract) due to our responsible attitudes toward customers and partners and our confidence in INVOLAR products. During the warranty period, if any defect in workmanship and materials of the INVOLAR micro-inverters is detected, customers is entitled by the warranty to ask for replacement or repairing from INVOLAR with no extra cost.

During the Warranty period, require the product invoices and purchase date for free replacement or repairing. The Limited Warranty does not cover the product which trademark is not visible.

The Limited Warranty does not cover following situations:

- Damaged by transportation
- Improperly installed
- Improperly operated
- Improperly handled or used
- Use under conditions for which the product was not designed or in an unsuitable environment.
- Any installation and use beyond the scope of relevant international standards
- Damage cause by non-normal natural environment

The exact product dimensions and technical data depend on the latest released version, like has the change without prior notice.

6.6 EC Declaration of Conformity

Certificate

This certificate is for the INVOLAR Corporation's eGate compliance to the relevant requirements.

INVOLAR Corporation hereby certifies the following in reference to the above product:

- 1) It fulfils all the safety requirements according to EN62109 -1 "Safety of power converters for use in photovoltaic power systems";
- 2) In case of power failure on the part of the power grid, it shall shut down and stop outputting voltage and current;
- 3) It fulfils the following requirements according to EN50438 "Requirement for the connection of micro-generators in parallel with public low-voltage distribution networks":
 - a) An automatic (re-)connection to the public grid is performed, provided that the grid voltage and frequency are within the range of 207-264V and 47 Hz-50.5Hz, respectively;
 - b) An immediate (0.5 s) disconnection is performed by the inverter, if the voltage, or the frequency or both are not within the limits of 207-264V or 47 Hz-50.5Hz, respectively;
 - c) Reconnection time after clearance of grid failure is no less than 180 seconds;
- 4) The total harmonic distortion of the output current (THD) is less than 2%.



Junyin Gu, 13.01.2010

CTO

INVOLAR Corporation,Ltd.